

11.2013

PORTES RELEVANTES

ROLL-UP
DOORS

ROLTORE



PORTECH

PORTECH

RIVETS · FERMETURES · CHARNIERES · SECTIONS · CABLES · ROULETTES · POIGNEES

RIVETS · LOCKS · HIGNES · PANELS · CABLES · ROLLERS · HANDLES

HOHLNIETEN · SCHLUB · SCHARNIER · SEGMENT · HOLZTTÜRSEIL · ROLLE · HUBGRIFF

Nous avons le plaisir de vous proposer une gamme complète de composants pour l'assemblage et la réparation des portes relevantes conforme avec norme NF13241.

Depuis sa création en 2003 et forte de l'expertise et de l'expérience de son fondateur, Portech n'a cessé d'accroître sa contribution à la fourniture de composants ainsi que d'accessoires à **prix discount** pour l'assemblage et la réparations des portes relevantes, (**Boyriven Fit, JR Industrie, Todco, Wihag, Henderson.**), tant en France qu'à l'exportation.

Portech vous permet d'acheter vos pièces détachées et des portes à des prix sans concurrences.

Toutes les pièces que nous vendons sont **Neuves, Conforme**, livrées dans leur emballage, elles proviennent des plus grands manufacturiers et sous-traitants de carrosserie industrielle.

Cette évolution motivée par la volonté permanente de satisfaire les exigences légitimes de nos clients en matière de qualité, délai et taux de service, nous a conduits à mettre en place une intégration poussée des moyens de production, ainsi qu'une logistique performante. Nos clients savent qu'ils peuvent compter sur notre fiabilité et ainsi améliorer leurs performances économiques en minimisant leurs stocks.

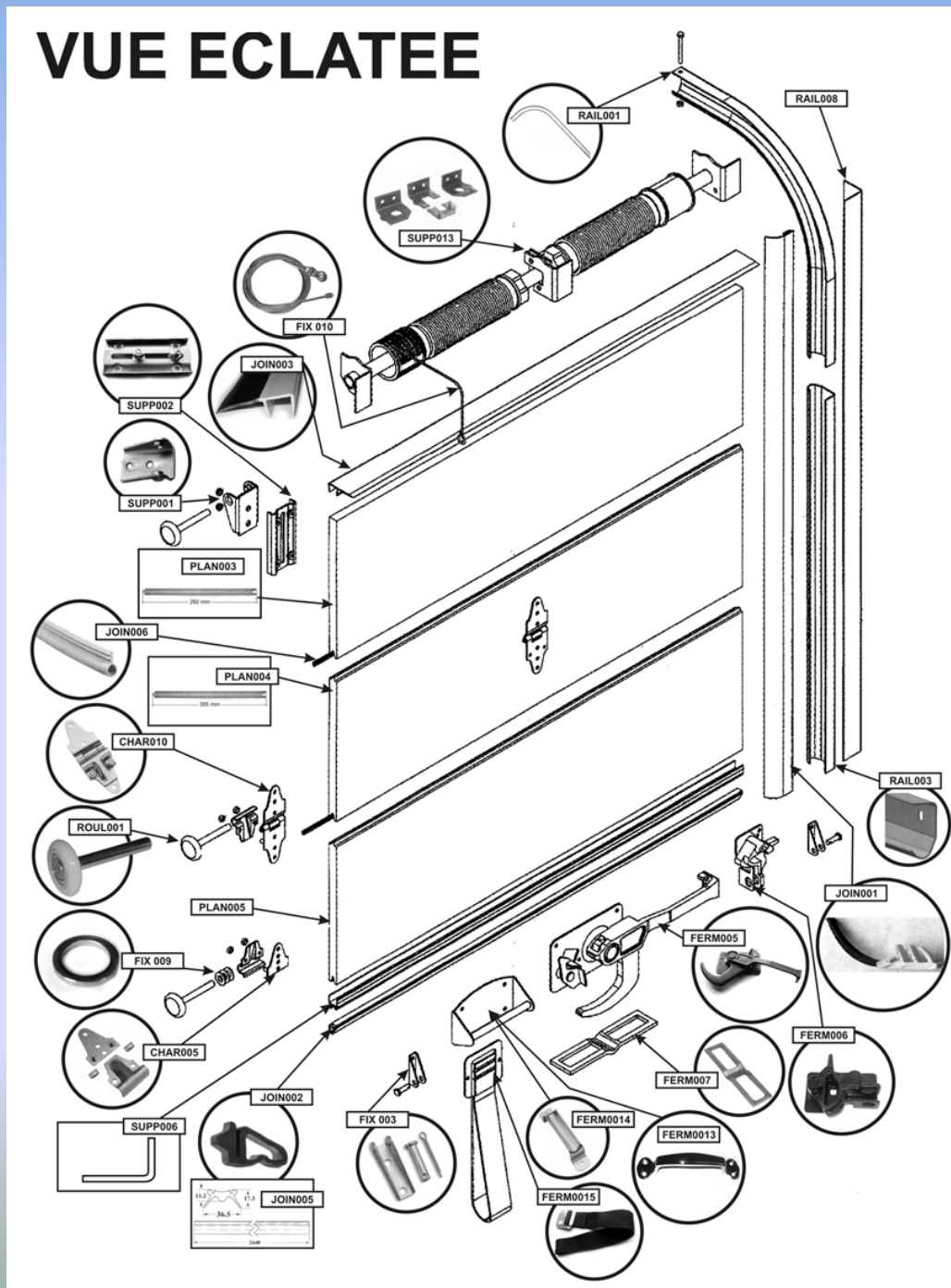

PORTECH

PORTE BOIS

Contreplaqué mélaminé blanc(deux faces) de 18 mm d'épaisseur

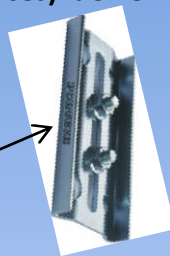

Support roulette haut réglable:

Permet d'assurer un bon appui du joint haut sur la traverse supérieure sans que la section haute ne touche l'équilibreur Lors de l'ouverture.



Charnière support roulette:

Avec goujons sertie + soudée
Configuration lisse pour ne pas accrocher les colis lors des manœuvres de la porte.
Guide roulette démontable facilement
Pour procéder rapidement aux opérations de maintenance.



Le nouveau profiles bas en Alu:

Permet le remplacement du joint bas sans démontage des attaches-câble, donc sans a
avec



POUR S'ADAPTER A VOS BESOINS PARTICULIERS, LA PORTE BOIS PORTECH PEUT RECEVOIR DE NOMBREUSES OPTIONS:

- ➔ Porte livrée laquée RAL sur demande
- ➔ Porte latéral
- ➔ Vantelle d'aération
- ➔ Hublot dans la section
- ➔ Fermeture TIR à clé
- ➔ Pour un usage intense -**Porte renforcées**
 1. Roulettes renforcées (6200RS)
 2. Supports bas renforcés
 3. Profile bas en alu renforcés
 4. Joint bas en doubles lèvres
 5. Attache câble renforcés



CARACTERISTIQUES TECHNIQUES

Bois en contreplaqué marine de 18 mm épaisseur – 13ply.

Les roulettes nylon diminuent le bruits.

L'ensemble de la visserie est réalisé
Sur le bases du système métrique,
Ce qui facilite le montage et la réparation.
L'assistance technique sur site (sur demande).

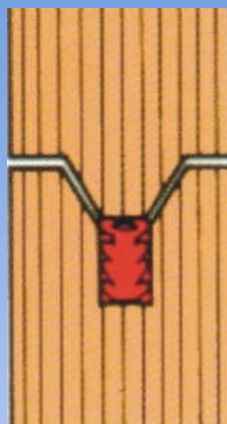



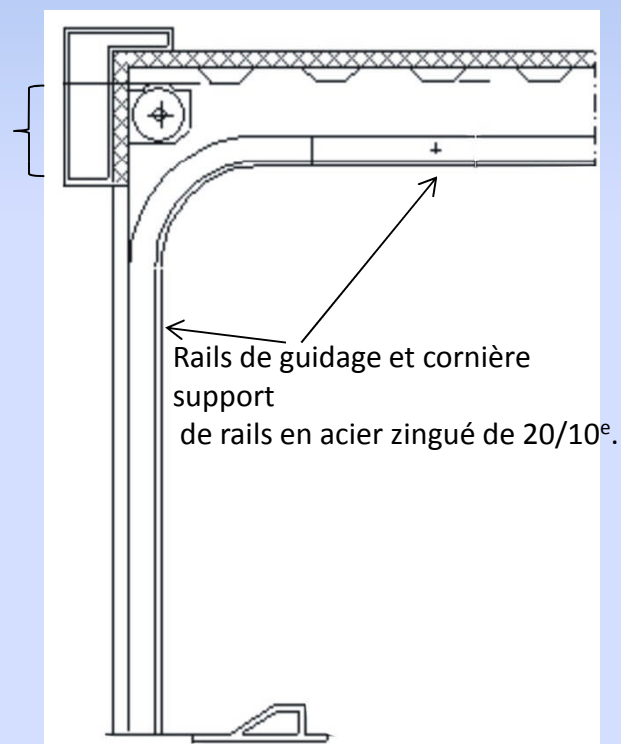



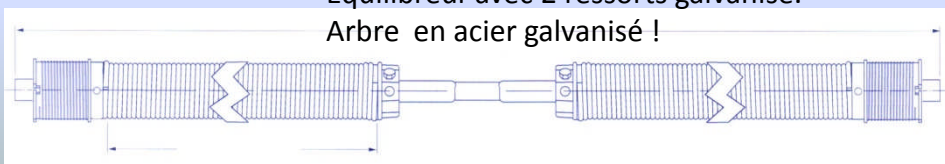

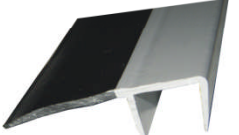
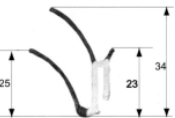
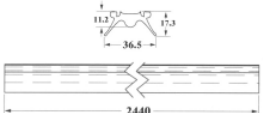

Linéau minimum 170mm



Equilibreur avec 2 ressorts galvanisé.
Arbre en acier galvanisé !



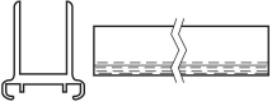







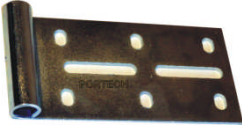



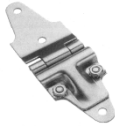



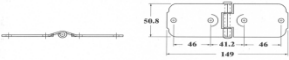







REFERENCE PART N° ART. NR°	DESIGNATION DESCRIPTION BEZEICHNUNG
<p>JOIN001</p> 	<p>630gr/pc</p> <p>Joint latéral long 2800mm Side seal lg 2800 mm Seitendichtung lange 2800mm</p>
<p>JOIN002</p> 	<p>450gr/pc</p> <p>Joint Bas am 2440mm Bottom Seal 2440mm Unter dichtung lg 2440mm</p>
<p>JOIN002 NM</p> 	<p>450gr/pc</p> <p>Joint Bas nouveau model 2440mm(montage avec SUPP007NM) Bottom Seal new model 2440mm Unter dichtung neues modell lg 2440mm</p>
<p>JOIN003</p> 	<p>630gr/pc</p> <p>Joint haut long 2440mm Top seal lg 2440 mm Ober dichtung lange 2440mm</p>
<p>JOIN004</p> 	<p>720gr/pc</p> <p>Joint latéral uni long. 2800mm Side seal lg 2800 mm Seitendichtung lange 2800mm</p>
<p>JOIN005</p> 	<p>510gr/pc</p> <p>Joint Bas am 2440mm Bottom Seal 2440mm Unter dichtung lg 2440mm</p>
<p>JOIN006</p> 	<p>105gr/pc</p> <p>Joint intersection long 2440mm Intermediate seal length 2440mm Zwischensegmentdichtung lange 2440mm</p>

REFERENCE PART N° ART. NR°	DESIGNATION DESCRIPTION BEZEICHNUNG
<p>JOIN007</p> 	<p>140gr/pc</p> <p>Joint latéral porte Alu ou Iso 55 . Au ml Side seal lg ml Seitendichtund ml</p>
<p>JOIN008</p> 	<p>gr/pc</p> <p>Joint Bas porte iso 2440mm Bottom Seal 2440mm Unter dichtung lg 2440mm</p> <p>NEW!</p>
<p>JOIN009</p> 	<p>gr/pc</p> <p>Joint Bas porte alu Train Plus 2440mm Bottom Seal Train Plus 2440mm Unter dichtung Train plus lg 2440mm</p> <p>NEW!</p>
<p>JOIN004H</p>	<p>gr/pc</p> <p>Joint latéral ISO F Style long 2800mm Side seal lg 2800 mm Seitendichtund lange 2800mm</p> <p>NEW!</p>
<p>SUPP007NM</p> 	<p>1250gr/pc</p> <p>Profile alu pour joint bas 2440 mm (montage avec JOIN002NM) Side seal lg 2800 mm Seitendichtund lange 2800mm</p>
<p>SUPP007I</p> 	<p>1830gr/pc</p> <p>Profile alu pour joint bas 2440mm (montage avec JOIN005) Side seal lg 2800 mm Seitendichtund lange 2800mm</p>
<p>SUPP008</p> 	<p>gr/pc</p> <p>Cornière support joint bas Iso lg 2440mm en Alu. Bottom seal Angles retainer lg 2440 mm Aluminium profil dichtungshalerung</p> <p>NEW!</p>















REFERENCE PART N° ART. NR°	DESIGNATION DESCRIPTION BEZEICHNUNG
<p>ROUL001</p> 	<p>150gr/pc</p> <p>Roulette nylon standard lg 115mm Nylon Roller lg 115mm Standard Nylon rolle lg 115mm</p>
<p>ROUL001 I</p> 	<p>150gr/pc</p> <p>Roulette nylon en INOX lg 115mm Nylon Roller STAINLESS STEEL lg 115mm Standard Nylonrolle EDELSTAHL lg 115mm</p>
<p>ROUL002</p> 	<p>150gr/pc</p> <p>Roulette renforcé nylon(roulement 6200) lg 115mm Nylon Roller (with bearing 6200) lg 115mm Standard Nylon rolle (mit lager 6200) lg 115mm</p>
<p>ROUL03</p> 	<p>130gr/pc</p> <p>Roulette 1" acier Galva - Style T 85mm Steel Roller 1" Lg 85 mm Rolle 1" Stahl Lg 85mm</p>
<p>ROUL004</p> 	<p>250gr/pc</p> <p>Roulette haute acier inox axe long Longueur 175mm Top Roller long stem Obere Rolle Längsachse</p>
<p>ROUL005</p> 	<p>150gr/pc</p> <p>Roulette nylon avec capuchon (protection) lg 115mm Nylon Roller with protection lg 115mm Nylon rolle mit schutz lg 115mm</p>
<p>ROUL006</p> 	<p>180gr/pc</p> <p>Roulette renforcé INOX nylon(roulement 6200) lg 190mm Nylon Roller (with bearing 6200) lg 190mm Standard Nylon rolle (mit lager 6200) lg 190mm</p>

REFERENCE PART N° ART. NR°	DESIGNATION DESCRIPTION BEZEICHNUNG
<p>ROUL007</p> 	<p>52gr/pc</p> <p>Roulette sans axe Roller nylon without stem Nylon rolle keine Achse</p>
<p>ROUL008</p> 	<p>150gr/pc</p> <p>Roulette renforcé INOX nylon(roulement 6200) lg 110mm Nylon Roller STAINLESS STEEL (with bearing 6200) lg 110mm Standard Nylon rolle EDELSTAHL (mit lager 6200) lg 110mm</p>
<p>ROUL003R</p> 	<p>130gr/pc</p> <p>Roulette 1"renforcé nylon(avec roulement) lg 85 mm Nylon Roller 1" (with bearing) lg 85mmmm Standard Nylon rolle 1" (mit lager) lg 85mmmm </p> 
<p>ROUL009</p> 	<p>140gr/pc</p> <p>Roulette 1"renforcé Inox (avec roulement) lg 85mm Stainless steel Roller 1" (with bearing) lg 85mm Edelstahl rolle 1" (mit lager) lg 85mm0mm </p>
<p>CHAR001</p> 	<p>135gr/pc</p> <p>Charnière centrale F Center hinge -Steel Zentalscharnier</p> <p>CHAR001B Charnière centrale Noir Center hinge -Steel black</p>  
<p>CHAR001 I</p> 	<p>135gr/pc</p> <p>Charnière centrale en INOX F Center hinge -stainless Steel Zentalscharnier edelstahl</p>
<p>CHAR005</p> 	<p>110gr/pc</p> <p>Support de roulette basse, complet avec guide roulette Bottom fixture bracket complete Halterung Unter roller, komplett</p>

REFERENCE PART N° ART. NR°	DESIGNATION DESCRIPTION BEZEICHNUNG
<p>CHAR005R</p> 	<p>190gr/pc</p> <p>Support de roulette basse, renforcée Bottom fixture bracket Halterung untere roller</p>
<p>CHAR006</p> 	<p>45gr/pc</p> <p>Guide de roulette basse Bottom roller guide Unter rollen Führung</p>
<p>CHAR007</p> 	<p>45gr/pc</p> <p>Guide de roulette Roller guide Rollen Führung</p>
<p>CHAR010</p> 	<p>198gr/pc</p> <p>Charnière support roulette complète Roller hinge Assembly Scharnier rollenhalterung komplett</p>  
<p>CHAR010I</p> 	<p>198gr/pc</p> <p>Charnière support roulette complète INOX Roller hinge Assembly STAINLESS STEEL Scharnier rollenhalterung komplett EDELSTAHL</p>
<p>CHAR014</p> 	<p>x gr/pc</p> <p>Anneau extérieur d 5 seul (montage sur CHAR009) Clip d 5. xxxxxxxx</p>
<p>CHAR015</p> 	<p>140gr/pc</p> <p>Charnière centrale Style T Center hinge –Steel T style Zentalscharnier T Style</p>  

REFERENCE PART N° ART. NR°	DESIGNATION DESCRIPTION BEZEICHNUNG
CHAR017 	 234gr/pc Charnière support roulette Roller hinge Scharnier rollenhalterung t
CHAR018 	 296gr/pc Charnière support roulette complète T Steel Roller hinge Assembly T Steel Scharnier rollenhalterung komplett T steel
CHAR002 	 185gr/pc Charnière support roulette T Style Roller hinge T Style Scharnier rollenhalterung T Style
CHAR009 	 12.6gr/pc Axe de charnière d6 complet avec anneau. Hinge anchor pin Scharnierachse 6 mm komplett
CHAR009I 	 12.6gr/pc Axe de charnière d6 INOX complet avec anneau . Hinge anchor pin stainless steel Scharnierachse 6 mm komplett Edelstahl
CHAR080 L 	 75gr/pc Guide de roulette porte Style Whiting – gauche (passager) Roller Bracket Style Whiting Passenger Side Rollenhakterung style Whiting Beifahrerseite.
CHAR080L 	 75gr/pc Guide de roulette porte Style Whiting – droite (chauffeur) Roller Bracket Style Whiting Driver Side Rollenhakterung style Whiting Fahrerseite.















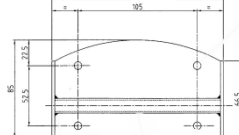

REFERENCE PART N° ART. NR°	DESIGNATION DESCRIPTION BEZEICHNUNG
CHAR0019 	 120gr/pc Charnière support roulette complète porte Isotherme Roller hinge Assembly Insulated door Scharnier rollenhalterung komplett Isolierte rollore
CHAR020 	 30gr/pc Guide Roulette Isotherme Style F ou Henderson Roller Guide Insulated door Rollen Führung Isolierte rollore
CHAR030 	 15gr/pc Guide Roulette Style Wihag- Train Plus lg 65mm Roller Guide Style Wihag- Train Plus lg 65mm Rollen Führung Style Wihag- Train Plus lg 65mm 
CHAR099 	 198gr/pc Charnière support roulette F style porte RR Roller hinge F style door RR Scharnier rollenhalterung F style RR
CHAR022 	 63gr/pc ½ Charnière Femelle ½ Hinge F style ½ Scharnier F Style
CHAR033 	 70gr/pc ½ Charnière Male ½ Hinge F style ½ Scharnier F Style
CHAR023 	 75gr/pc ½ Charnière Femelle avec 2 goujons m6 x 12mm ½ Hinge F style ½ Scharnier F Style







REFERENCE PART N° ART. NR°	DESIGNATION DESCRIPTION BEZEICHNUNG
FIX010 	 210gr/pc Câble de porte en Inox 3mm Longueur 3305mm Roll up door cable lg 3305mm stainless steel Holztürseil 3mm Länge 3305mm Edelstahl
FIX011 	 200gr/pc Câble de porte en Inox 3mm Longueur 3175mm Roll up door cable lg 3175mm stainless steel Holztürseil 3mm Länge 3175mm Edelstahl
FIX003 	 43gr/pc Attache câble D 8 Complet Cable anchor bracket complete Kabelbefestigung D8 Komplett
FIX003 ISO 	 85gr/pc Attache câble D 8 Renforcée pour porte iso ou pvc... Cable anchor bracket D8 Kabelbefestigung D8
FIX004 	 14gr/pc Axe d'attache câble avec goupille Cable anchor pin with cotter Kabelbefestigungsachse mit splint
FIX001 	 2.8gr/pc Rivet Foré alu ou acier 6 x 26mm Rivets 6 x 26mm Steel / alu Hohlrieten 6x 26mm
FIX001L 	 2.85gr/pc Rivet Foré alu ou acier 6 x 26mm Rivets 6 x 26mm steel / alu Hohlrieten 6x 26mm

REFERENCE PART N° ART. NR°	DESIGNATION DESCRIPTION BEZEICHNUNG
FIX005 	 120gr/pc Vis de réparation m6 x 30mm Step Bolt m6 x 30 Schraube Reparatur m6 x 30mm
FIX015 	 30gr/pc Vis de réparation UNC 6.35 x 30mm Step Bolt ¼ x 1"15 Schraube Reparatur 6.35 x 30mm
FIX019 	 30gr/pc Vis de réparation m6 x 30mm avec insert bois Step Bolt m6 x 30 Schraube Reparatur m6 x 30
FIX008 	 2gr/pc Ecrou M6 Nylstop Nut m6 Mutter m6
FIX009 	 1.65gr/pc Rondelle de calage d12mm Spacer washer d12mm Unterlegscheibe (Klemmscheibe) d12mm
FIX012 	 17.5gr/pc Boulon de fixation –pour le Rail m 6 x 60mm Fixing Bolt m6 x 60mm Feststellschraube echskantkopf m6 x 60mm
FIX014 	 7.7gr/pc Goupille fendue 5 x 38 mm pour arbre 25.4mm Cotter pin 5 x 38mm Splint 5 x 38mm

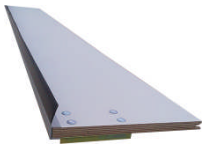
REFERENCE PART N° ART. NR°	DESIGNATION DESCRIPTION BEZEICHNUNG
<p>FIX017</p> 	<p> gr/pc</p> <p>Rivet pop 6 x 15mm acier Galva Rivets 6 x 15mm Hohlrieten 6 x 15mm</p>
<p>FIX018</p> 	<p> gr/pc</p> <p>Rivet éclaté 6.4 x 24 en Alu Rivets 6.4 x 24 Hohlrieten 6.4 x 24</p>
<p>FIX020</p> 	<p> 68gr/pc</p> <p>Butée d'arrêt Bumper Gumpuffer</p>
<p>FERM005</p> 	<p> 2.6kg/pc</p> <p>Fermeture Standard <i>Cam Lock</i> Standard verschluß, einzeln</p>
<p>FERM006</p> 	<p> 730gr/pc</p> <p>Verrouillage Standard <i>Standard Keeper</i> Standardverriegelung</p>
<p>FERM006F</p> 	<p> 750gr/pc</p> <p>Verrouillage Standard a clés <i>Standard Keeper</i> Standardverriegelung</p> 
<p>FERM007</p> 	<p> 390gr/pc</p> <p>Gâche standard F <i>Latch Plate F</i> Standardschließblech (versenkter Einbau)</p>

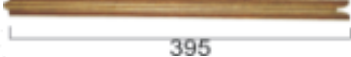
REFERENCE PART N° ART. NR°	DESIGNATION DESCRIPTION BEZEICHNUNG
FERM008 	 2.75Kg/pc Fermeture standard T STYLE <i>Cam Lock T STYLE</i> Standard verschluß, einzeln T STYLE
FERM009 	 670gr/pc Verrouillage standard T STYLE <i>Standard Keeper T STYLE</i> Standardverriegelung T STYLE
FERM010 	 390gr/pc Gâche standard T Style <i>Latch Plate T style</i> Standardschließblech (versenkter Einbau) T style
FERM011 	 5.8kg/pc Fermeture compact W Style #75-10 pour porte Isotherme <i>Cam Lock for „Coldsaver“ or „tempsaver“ Insulated door</i> Verschluß, einzeln W STYLE Isolierte roltore
FERM012 	 4.8kg/pc Fermeture compact W Style #70 pour porte bois <i>Cam Lock Assy W Style #70</i> Verschluß, einzeln W Style 
FERM012F 	 4.95kg/pc Fermeture W Style #70 pour porte bois avec barillet Yale <i>Cam Lock Assy W Style #70 with key Yale</i> Verschluß, einzeln W Style Mit Schlüssel Yale 
FERM013 	 365gr/pc Poignée de levage Portech <i>Lift handle Portech</i> Hubgriff Portech

REFERENCE PART N° ART. NR°	DESIGNATION DESCRIPTION BEZEICHNUNG
<p>FERM014</p> 	<p> 210gr/pc</p> <p>Poignée de levage W <i>Lift handle W</i> Hubgriff W</p>  
<p>FERM016</p> 	<p> 465gr/pc</p> <p>Poignée de levage F Style <i>Lift handle F Style</i> Hubgriff F Style</p> 
<p>FERM031</p> 	<p> 30gr/pc</p> <p>Barillet Yale avec 2 clés montage sur FERM012 F Cylinder Yale Schlüssel Yale</p>
<p>FERM015</p> 	<p> 198gr/pc</p> <p>Dragonne standard Longueur 600mm Pull strap assemblée length 600mm Standardschlaufe länge 600mm</p>
<p>FERM017</p> 	<p> 63gr/pc</p> <p>Dragonne standard Longueur 1000mm Pull strap assemblies length 1000mm Standardschlaufe länge 1000mm</p>
<p>FERM018</p>	<p> gr/pc</p> <p>Fermeture Special <i>Cam Lock</i> Verschluß, einzeln</p> 
<p>FERM019</p>	<p> gr/pc</p> <p>Fermeture Special <i>Cam Lock</i> Verschluß, einzeln</p>

REFERENCE PART N° ART. NR°	DESIGNATION DESCRIPTION BEZEICHNUNG
<p>PLAN001</p> 	<p>11kg/pc</p> <p>Section haute, seule ___ x ___ mm-- Mélaminé Blanc 18mm <i>Top section Melamine White 18mm</i> Oberes Segment einzeln, x mm 18mm</p>
<p>PLAN002</p> 	<p>12kg/pc</p> <p>Section haute, complète ___ x ___ mm Mélaminé Blanc 18mm <i>Top section with top seal complete....X....mm 18mm</i> Oberes Segment komplett,.... X.... Mm 18mm</p>
<p>PLAN003</p> 	<p>9kg/pc</p> <p>Section intermédiaire 18mm 292 x ___ mm Mélamine Blanc <i>Intermediate panel 292 x ___ mm</i> Zwischensegment, 292 x mm</p>
<p>PLAN004</p> 	<p>12kg/pc</p> <p>Section intermédiaire 18mm 395 x ___ mm Mélaminé Blanc <i>Intermediate panel 18mm x 395 x ___ mm</i> Zwischensegment, 18mm x 395 X ___ mm</p>
<p>PLAN005</p> 	<p>13.6kg/pc</p> <p>Section basse, avec profilé et joint, 395 x ___ mm Mélaminé Blanc <i>Bottom section 395mm x mm with U channel and Bottom seal. White.</i> Unteres Segment mit Profil und Dichtung, 395 x mm</p>
<p>PLAN006</p> 	<p>18.5kg/pc</p> <p>Section basse complète, 395 x ___ mm avec fermeture standard Blanc <i>Bottom section complete, 395mm x ___ mm with standard lock Style F</i> Unteres Segment mit Profil und Dichtung, 395 x ___ mm</p>
<p>PLAN007</p> 	<p>18.6kg/pc</p> <p>Section basse complète, 395 x ___ mm avec fermeture T Blanc <i>Bottom section complete, 395mm x ___ mm with lock Style T</i> Unteres Segment mit Profil und Dichtung, 395 x ___ mm</p>

REFERENCE
PART N°
ART. NR°

DESIGNATION
DESCRIPTION
BEZEICHNUNG

PLAN008



11kg/pc

Section basse complète, 395 x__ mm avec FERM018 Blanc
Bottom section complete , 395mm x _____ mm with LOCK FERM012
 Unteres Segment mit Profil und Dichtung, 395 x__ mm

PLAN009

12kg/pc

Section Inter porte Isotherme 400mm 60 mm épaisseur
Intermediate panel 400 x 2440mm
 Zwischensegment, 400 X 2440 mm



PLAN011

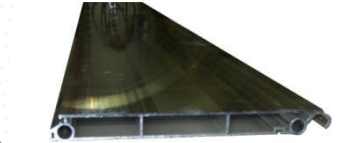

9kg/pc

Section basse Seul , 25mmx 275mm x 2500 En Alu porte Wihag –Train Plus
Bottom section
 Unteres Segment



PLAN012



12kg/pc

Section intermédiaire25mm 293 x en Alu Porte Wihag –Train Plus
Intermediate panel 395 x _____ mm
 Zwischensegment, 395 X_____ mm



PLAN013



13.6kg/pc

Section intermédiaire25mm 293 x en Alu Porte Wihag –Train Plus
Intermediate panel 395 x _____ mm
 Zwischensegment, 395 X_____ mm

















PLAN014









kg/pc







PLAN015

kg/pc

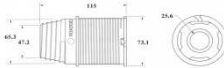
<p>REFERENCE PART N° ART. NR°</p>	<p>DESIGNATION DESCRIPTION BEZEICHNUNG</p>
<p>SUPP001</p> 	<p>155kg/pc</p> <p>Support de roulette haut Roller carier Halterung obere Roller</p>
<p>SUPP002</p> 	<p>190kg/pc</p> <p>Glissière complète, avec visserie Top Closure base with bolts Gleitschiene, komplettmit Verschraubungen</p>
<p>SUPP021</p> 	<p>kg/pc</p> <p>Support roulette haut portes- pvc-iso.rr <i>Top roller carier Insulated door, pvc door, rr door</i> Halteun ober roller Isolierte roltore, pvc tore ...</p> 
<p>SUPP022</p> 	<p>kg/pc</p> <p>Guide de roulette porte pvc, iso.... <i>Roller guide Insulated door, pvc door, rr door</i> Rollenführung Isolierte roltore, pvc tore ...</p> 
<p>SUPP018</p> 	<p>675kg/pc</p> <p>Support roulette haut portes- isotherme côté passager <i>Top roller carier Insulated door, passenger side</i> Halteun ober roller Isolierte roltore, beifahrerseite</p>
<p>SUPP017</p> 	<p>380kg/pc</p> <p>Support roulette haut portes- isotherme côté chauffeur <i>Top roller carier Insulated door, driver side</i> Halteun ober roller Isolierte roltore, fahrerseite.</p>
<p>SUPP013</p> 	<p>380kg/pc</p> <p>Jeu complet de supports d'équilibreur zinguee <i>Complete set of Spring Brackets</i></p>

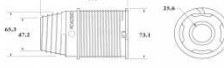
REFERENCE PART N° ART. NR°	DESIGNATION DESCRIPTION BEZEICHNUNG
EQUI0014 	 170gr/pc Roulement 1" avec flasque <i>Bearing and bracket plate assembly</i> <i>Console für Federwelle verzinkt.</i>
EQUI0017 	 380gr/pc Palier intermediaire Zinguee T Style <i>Spring Anchor Bracket, Galvanised</i>
EQUI0013 	 380gr/pc Palier intermediaire Zinguee T Style <i>Spring Anchor Bracket, Galvanised</i>
EQUI004 	 2.54kg/pc Arbres d` equilibreur 25mm x 2210mm <i>Shaft length 2210mm</i> <i>Welle, Länge 2210 mm</i>
EQUI005 	 2.45kg/pc Arbres d` equilibreur 25mm x 2134mm <i>Shaft length 2134mm</i> <i>Welle, Länge 2134 mm</i>
EQUI008 	 2.45kg/pc Arbres d` equilibreur 25mm x 2311mm <i>Shaft length 2311mm</i> <i>Welle, Länge 2311 mm</i>
EQUI0015 	 2.65kg/pc Arbre pour Porte T style 25.4 mm <i>Shaft T style</i> <i>Welle T style</i>

REFERENCE PART N° ART. NR°	DESIGNATION DESCRIPTION BEZEICHNUNG
RAIL001 	 4.2kg/pc Rail courbe 2", rayon 204 mm (la paire) <i>Track 2" Radius 204mm (the pair)</i> Schiene 2", Radius 204 mm (im Paar)
RAIL002 	 4.2Kg/pc Rail courbe 2", rayon 254 mm (la paire) <i>Track 2" Radius 254mm (the pair)</i> Schiene 2", Radius 254 mm (im Paar)
RAIL003 	 4Kg/pc Rail droit 2", longueur 3000 mm <i>Track 2" length 3000mm</i> Schiene 2", Länge 3000 mm
RAIL004 	 8.2kg/pc Ens. Cornière/Rail droit lg. 2971/2616 mm (la paire) <i>Track 2" welded with Mouting Angles (the pair)</i> Baugruppe Winkelprofil/Schiene L. (im Paar)
RAIL008 	 3.8kg/pc Cornière 45 x 45, longueur 2971 mm <i>Mouting Angle 45 x 45 length 2971 mm</i> Winkelprofil 45 x 45, Länge 2971 mm
RAIL009 	 2.65kg/pc Rail courbe 1", rayon 204 mm (coté chauffeur) <i>Track 2" Radius 204mm (the Driver Side)</i> Schiene 2", Radius 204 mm (Fahrerseite) 
RAIL010 	 2.65kg/pc Rail courbe 1", rayon 204 mm (coté passager) <i>Track 2" Radius 204mm (Passanger Side)</i> Schiene 2", Radius 204 mm (Beiharerseite) 

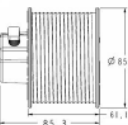
REFERENCE PART N° ART. NR°	DESIGNATION DESCRIPTION BEZEICHNUNG
<p>EQUI001</p> 	<p> 270gr/pc</p> <p>Tambour enrouleur côté chauffeur Cable drum Driver Side PVC Kabel trommel breit fahrerseite.</p>  
<p>EQUI002</p> 	<p> 270gr/pc</p> <p>Tambour enrouleur côté passager Cable drum Passenger Side PVC Kabel trommel breit beifahrerseite</p>  
<p>EQUI003P</p> 	<p> 470gr/pc</p> <p>Pièce d'immobilisation complète W/F STYLE Spring Anchor Cone Stelling komplett</p>  
<p>EQUI009</p> 	<p> 190gr/pc</p> <p>Pièce d'immobilisation complète T STYLE 51mm existe en 45mm Spring Anchor Cone Stelling komplett</p>
<p>EQUI010</p> 	<p> 375gr/pc</p> <p>Tambour enrouleur T style côté chauffeur T-Style Cable Drum Driver Side ALU Kabel trommel breit fahrerseite</p>  
<p>EQUI011</p> 	<p> 375gr/pc</p> <p>Tambour enrouleur T style côté passager T-Style Cable Drum Passenger Side ALU Kabel trommel breit beifahrerseite</p>  
<p>EQUI012</p> 	<p> 170gr/pc</p> <p>Pièces de torsion 51mm – existe en 45mm Spring Anchor Plug</p>

PORTECH

ENSEMBLE RESSORT STYLE -WHITING - FIT

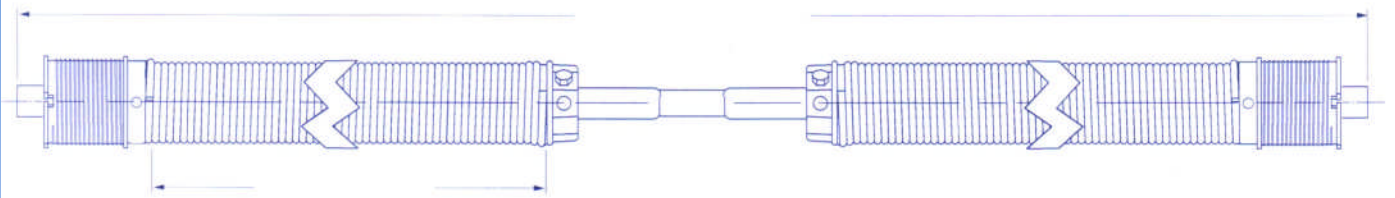

Paramètre des ressorts de torsion

Torsion springs' basic parameters

L- Longueur du ressort
D- Diamètre intérieur du ressort
d- Diamètre du fil

L - length of spring
 D - internal diam. of spring
 d - diam. of wire

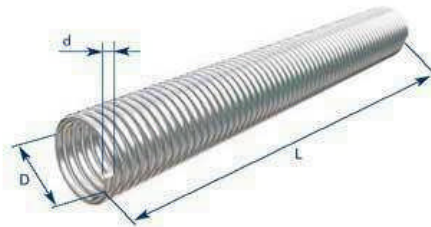

Ressort "spires à droite"
 Right winding

Ressort "spires à gauche"
 Left winding

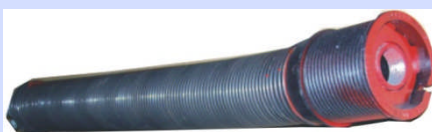

←
Côté Rouge
 Chauffeur



←
Côté Noir
 Passager

ENSEMBLE RESSORT STYLE TODCO - WIHAG



Longueur : sur mesure

Diamètres du fil 4mm, 4.5, 5, 5.5, 6mm

Diamètres inférieur 45 ou 51mm



REFERENCE
PART N°
ART. NR°

DESIGNATION
DESCRIPTION
BEZEICHNUNG



2.4Kg/pc

EQU1008 Ensembles ressort 3.9 X 445--lg complet-638mm Chauffeur.
W-Style Spring Assemblies Driver Side 3.9x445---638

EQU1009 Ensembles ressort 3.9 X 445--lg complet-638mm Passager.
W-Style Spring Assemblies Passenger Side 3.9x445---638

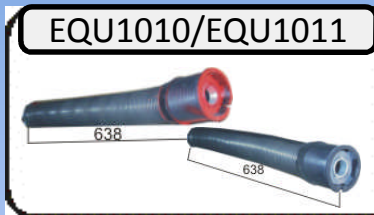

2.9Kg/pc

EQU1010 Ensembles ressort 3.9 X 445--lg complet-638mm Chauffeur.
W-Style Spring Assemblies Driver Side 3.9x445---638

EQU1011 Ensembles ressort 3.9 X 445--lg complet-638mm Passager.
W-Style Spring Assemblies Passenger Side 3.9x445---638

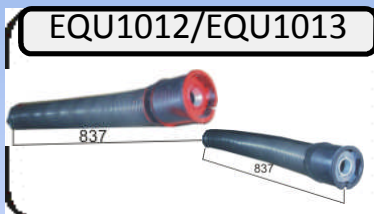

4.0Kg/pc

EQU1012 Ensembles ressort 4.3 X 635--lg complet-837mm Chauffeur.
W-Style Spring Assemblies Driver Side 4.3x635---837

EQU1013 Ensembles ressort 4.3 X 635--lg complet-837mm Passager.
W-Style Spring Assemblies Passenger Side 4.3x635---837

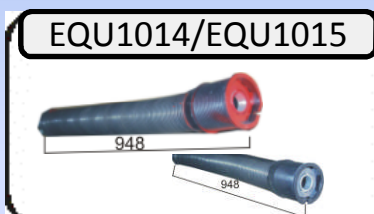

4.7Kg/pc

EQU1014 Ensembles ressort 4.5 X 737--lg complet-948mm chauffeur.
W-Style Spring Assemblies Driver Side 4.5x727---948

EQU1015 Ensembles ressort 4.5 X 737--lg complet-948mm Passager.
W-Style Spring Assemblies Passenger Side 4.5x727---948

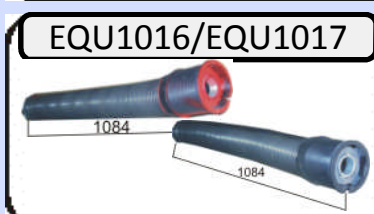

5.8Kg/pc

EQU1016 Ensembles ressort 4.9 X 864--lg complet-1084mm chauffeur.
W-Style Spring Assemblies Driver Side 4.9x864---1084

EQU1017 Ensembles ressort 4.9 X 864--lg complet-1084mm Passager.
W-Style Spring Assemblies Passenger Side 4.9x864---1084



6Kg/pc

EQU1018 Ensembles ressort XX x XXX--lg complet-XXX mm chauffeur. SUR
DEMANDE
W-Style Spring Assemblies Driver Side

EQU1019 Ensembles ressort XX x XXX --lg complet-XXXX mm Passager.
SUR DEMANDE
W-Style Spring Assemblies Passenger Side

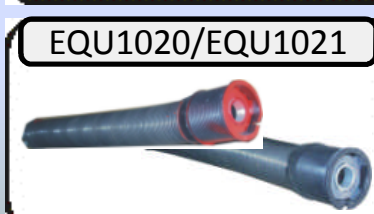

6Kg/pc

EQU1020 Ensembles ressort 5.0 -lg complet-1020mm Chauffeur.
W-Style Spring Assemblies Driver Side 5.0 ---1020

EQU1021 Ensembles ressort 5.0-lg complet-1020mm Passager.
W-Style Spring Assemblies Passenger Side 5.0 X 1020

PORTECH

Large gamme de **ressorts** zinguée, **ressorts** préassemblés



**Côté
Rouge
Chauffeur**



**Côté
Noir
Passager**

REFERANCE		CARACTERISTIQUES TECHNIQUES whiting-fit			
CHAUFFEUR	PASSAGER	DIMENSION DU RESSORT	COULEUR	LG ENS RESSORT X	UTILISATION
EQU1008	EQU1009	3.4 X 315		514	PB
EQU1010	EQU1011	3.9 X445	VERT/BLANC	638	PB
EQU1012	EQU1013	4.3 X 635	Jeune	837	PB,PVC,
EQU1014	EQU1015	4.5 X 737	Vert	946	PB,PVC,
EQU1016	EQU1017	4.9 X 864	Rouge	1084	PB,RR,PVC,ISO
EQU1018	EQU1019	5 X 810		1020	RR-WIHAG
EQU1020	EQU1021	4.5 X 686	Bleu/Clair	896	RR,ISO
EQU1022	EQU1023	5.2 X 765		970	ISO, WIHAG
EQU1024	EQU1025	5.5 X 882		1089	ISO
EQU1032	EQU1033	4.7 X 677	Violet	880	RR,ISO
EQU1030	EQU1031	4.7 X 813	Blanc	1020	RR,ISO

REFERENCE
PART N°
ART. NR°



BALUN610



 gr/pc

Raclettes universelles auto-cassante lg 610mm



BALUN710



 gr/pc

Raclettes universelles auto-cassante lg 710mm



BALVAL



 gr/pc

Raclettes plat adaptable plats Valeo. Lg 700mm
Les caoutchoucs d'essuie-glace doivent simplement être recoupés à la longueur.
Livrée avec embouts.



BALBOSC



 gr/pc

Raclettes adaptable Aero twin Bosch lg 750mm
Les caoutchoucs d'essuie-glace doivent simplement être recoupés à la longueur.
Livrée avec embouts



BALCRO





 gr/pc

Raclettes Universelles à crochet métallique lg 710mm

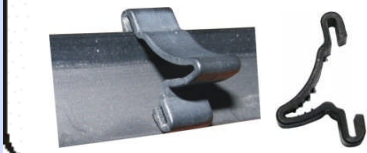

BALCLIP1



 gr/pc

Accrochage crochet pour Montage Type Valeo



BALCLIP2



 gr/pc

Accrochage crochet pour Montage Type Bosch



PORTECH

BON DE COMMANDE

 **Fax (33) 1 64 96 83 73**

FACTURATION :

NOM :

SOCIETE :

ADRESSE :

 / / / / /

 / / / / / / / / / / /

 / / / / / / / / / / /

SIGNATURE ou TAMPON

POINT DE LIVRAISON (si différent de facturation)

NOM :

Adresse :

.....

 / / / / /

N°	REF PORTECH	DESIGNATION	QTE	P.U	TOTAL
1					
2					
3					
4					
5					
6					
7					
8					
9					
10					
11					
12					
13					

**UTILISEZ DE FORMULAIRE PLUSIEURS FOIS EN
FAISANT UNE PHOTOCOPIE DES MAINTENANT**



PORTECH

Sarl Portech, Zone d'activité du Bel Air Rd 97
91640 Fontenay les Briis. France
Tél + 33 1 64 91 53 22; Fax + 33 1 64 96 83 73; Web:www.portech.fr